

Data Sheet



Article number: 604133048170

Description: Taper bored timing belt pulley
HTD 48 14M 170 TL 3535

Measures

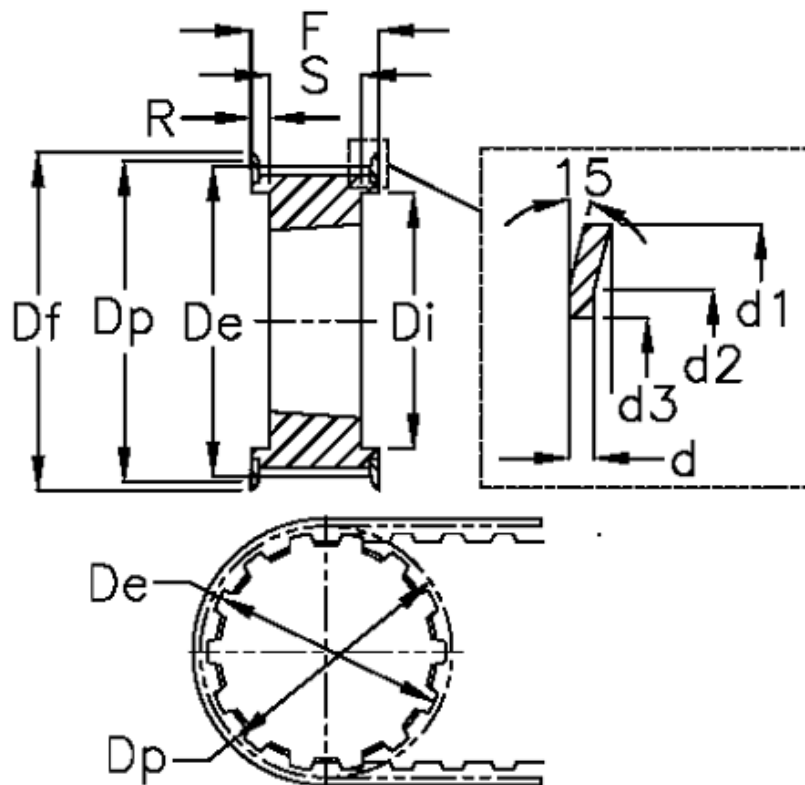

d = 2.5	F = 187	Weight = 19
d1 = 226	Flange type = F62	Width = 170
d2 = 214	For bushing = 3535	
d3 = 190	Max bore = 90	
De = 211.11	r = 49	
Df = 226	S = 89	
Di = 170	Tooth number = 48	
Dp = 213.9	Type = 14M	